



HIGH EFFICIENCY CONDENSING BOILER-PLANT

G Series

USER'S MANUAL

**FOR MODULATING BOILER WITH GAS BURNER
EQUIPPED FOR NATURAL GAS**

**Type : B23
Category I2H**

Equipment complying with European Community Directives:

- Low voltage (73/23/CEE)
- Electromagnetic compatibility (89/336/CEE)
- Efficiency (92/42/CEE)
- as appliancez (90/396/CEE)

ADDRESS: ATLANTIC BOILERS, PO BOX 11, ASHTON UNDER LYNE, OL6 7TR
WEB: WWW.ATLANTICBOILERS.COM **EMAIL:** INFO@ATLANTICBOILERS.COM
TEL: 0161 621 5960 **FAX:** 0161 621 5966

CONTENTS

| | |
|--|-----------|
| CONTENTS | 3 |
| 1 Technical characteristics. | 4 |
| 2 Installation. | 6 |
| 3 Start-up. | 6 |
| 4 Shut-down. | 6 |
| 5 Maintenance. | 6 |
| 6 Frost protection. | 6 |
| 7 User interface and boiler management. | 7 |
| 7.1 Presentation of the interface | 7 |
| 7.2 LCD display | 7 |
| 7.3 Operating modes | 8 |
| 7.4 Set-point adjustment | 10 |
| 7.5 Information on boiler status | 11 |
| 7.6 Parameter setting | 14 |
| 8 Operation of control cabinet. | 15 |
| 9 List of parameters. | 16 |

1 Technical Characteristics.

This G Series boiler has been adjusted in the works for **group H natural gas (type G20)**, gas supply pressure 20 mbar or 300 mbar (see data plate).

Any interference with sealed parts will invalidate the warranty

Rated, minimum and maximum gas pressures.

| Model | Type H gas (Lacq) (G20) | | Type L gas (Groningue) (G25) | |
|-------------------------|-------------------------|----------|------------------------------|----------|
| | 20 mbar | 300 mbar | 25 mbar | 300 mbar |
| Rated pressure (mbar) | 20 | 300 | 25 | 300 |
| Minimum pressure (mbar) | 17 | 270 | 20 | 270 |
| Maximum pressure (mbar) | 25 | 330 | 30 | 330 |

Combustion characteristics at 15°C and 1013 mbar.

OPTIMAGAZ

| Model – G Series | | Unit | G116 | G145 | G174 | G232 | G291 | G348 | G407 | G465 |
|--|-----|-------------------|-------------------|-------|-------|-------|-----------|-------|-----------|-------|
| Combustion at 15°C and 1013 mbar | | | | | | | | | | |
| Rated pressure P | | kW | 114 | 144 | 173 | 230 | 288 | 345 | 403 | 423 |
| Heat output | Max | kW | 121,3 | 151,5 | 185,0 | 248,0 | 306,0 | 368,0 | 435,0 | 455,0 |
| | Min | kW | 30,0 | 37,5 | 47,0 | 61,5 | 77,0 | 93,0 | 109,0 | 112,0 |
| Gas flow (G20) | Max | m ³ /h | 12,8 | 16,0 | 19,6 | 26,2 | 32,4 | 38,9 | 46,0 | 48,1 |
| | Min | m ³ /h | 3,2 | 4,0 | 5,0 | 6,5 | 8,2 | 9,8 | 11,5 | 11,9 |
| CO ₂ content (G20) | Max | % | 8.5 – 8.7 | | | | 8.7 – 8.9 | | 8.9 – 9.0 | |
| | Min | % | 8.0 – 8.2 | | | | | | | |
| Flue gas flow | Max | g/s | 57 | 71 | 87 | 118 | 142 | 171 | 199 | 208 |
| | Min | g/s | 15 | 19 | 24 | 31 | 39 | 47 | 55 | 56 |
| Flue gas temperature (60/80 °C operating mode) | Max | °C | 134 | 136 | 138 | 139 | 138 | 146 | 145 | 142 |
| | Min | °C | 63 | 64 | 65 | 67 | 66 | 67 | 69 | 72 |
| Intake air flow at 1013 mbar and 15°C | Max | m ³ /h | 160,4 | 200,3 | 244,6 | 331,4 | 400,3 | 481,4 | 557,4 | 583,1 |
| | Min | m ³ /h | 42,4 | 53,0 | 67,1 | 86,8 | 108,7 | 131,3 | 153,9 | 158,2 |
| Average weighted annual emission of NO _x according to EN656 | | mg/kWh | 35 | 45 | 50 | 45 | 55 | 55 | 50 | 50 |
| Hydraulic characteristics | | | | | | | | | | |
| Safe temperature limit | | °C | 106 | | | | | | | |
| Outlet water temperature adjustment range | | °C | 65 – 90 | | | | | | | |
| Minimum return water temperature | | °C | 45 | | | | | | | |
| Water pressure | Max | bar | 4 | | | | | | | |
| | Min | bar | 1 (cold) | | | | | | | |
| Water capacity | | L | 116 | 144 | 153 | 256 | 285 | 315 | 342 | 371 |
| Rated water flow rate through boiler | | m ³ /h | P/20 (max = P/15) | | | | | | | |
| Hydraulic pressure loss in boiler at P/20 | | mCE | 1,22 | 1,43 | 1,0 | 1,27 | 1,17 | 0,71 | 0,87 | 1,17 |
| Sundry | | | | | | | | | | |
| Weight empty | | kg | 370 | 405 | 440 | 550 | 600 | 660 | 725 | 780 |

CONDENSAGAZ

| Model – G Series... | Unité | G116 | G145 | G174 | G232 | G291 | G348 | G407 | G465 |
|--|------------------------|------------------|-------|-------|-------|-----------|-------|-----------|-------|
| Combustion at 15°C and 1013 mbar | | | | | | | | | |
| Rated pressure P | kW | 116 | 145 | 174 | 232 | 290 | 348 | 407 | 443 |
| Heat output | Maxi kW | 119,7 | 148,7 | 181,0 | 241,0 | 297,0 | 359,0 | 423,5 | 462,0 |
| | Mini kW | 30,0 | 37,0 | 45,0 | 60,0 | 74,5 | 90,0 | 106,0 | 115,0 |
| Gas flow (G20) | Maxi m ³ /h | 12,7 | 15,7 | 19,2 | 25,5 | 31,4 | 38,0 | 44,8 | 48,9 |
| | Mini m ³ /h | 3,2 | 3,9 | 4,8 | 6,4 | 7,9 | 9,5 | 11,2 | 12,2 |
| CO ₂ content (G20) | Maxi % | 8.5 – 8.7 | | | | 8.7 – 8.9 | | 8,9 – 9,0 | |
| | Mini % | 8.0 – 8.2 | | | | | | | |
| Flue gas flow | Maxi g/s | 56 | 70 | 85 | 114 | 138 | 167 | 194 | 202 |
| | Mini g/s | 15 | 19 | 23 | 30 | 36 | 45 | 53 | 58 |
| Flue gas temperature (60/80 °C operating mode) | Maxi °C | 75 | | 78 | 77 | 75 | 76 | 79 | 78 |
| | Mini °C | 57 | | 59 | 58 | 59 | 56 | 59 | 60 |
| Intake air flow at 1013 mbar and 15°C | Maxi m ³ /h | 158,2 | 196,6 | 239,3 | 322,0 | 388,5 | 469,6 | 542,7 | 592,0 |
| | Mini m ³ /h | 42,4 | 52,2 | 64,3 | 85,7 | 105,2 | 127,1 | 149,7 | 162,4 |
| Average weighted annual emission of NO _x according to EN656 | mg/kWh | 40 | | 45 | 45 | 50 | 55 | 55 | 55 |
| Hydraulic characteristics | | | | | | | | | |
| Safe temperature limit | °C | 106 | | | | | | | |
| Outlet water temperature adjustment range | °C | 65 – 90 | | | | | | | |
| Minimum return water temperature | °C | 45 | | | | | | | |
| Water pressure | Maxi bar | 4 | | | | | | | |
| | Mini bar | 1 | | | | | | | |
| Water capacity | L | 140 | 175 | 185 | 296 | 328 | 359 | 391 | 424 |
| Rated water flow rate through boiler | m ³ /h | P/20 (Max: P/15) | | | | | | | |
| Rated water flow rate through condensation heat exchanger | Maxi m ³ /h | P/15 | | | | | | | |
| | Mini m ³ /h | P/45 | | | | | | | |
| Hydraulic pressure loss in boiler at P/20 | mCE | 1,22 | 1,4 | 1,0 | 1,27 | 1,17 | 0,71 | 0,87 | 1,17 |
| Hydraulic pressure loss in condensation heat exchanger at P/20 | mCE | 0,22 | 0,18 | 0,25 | 0,15 | 0,22 | 0,25 | 0,31 | 0,38 |
| Sundry | | | | | | | | | |
| Weight empty | kg | 425 | 450 | 485 | 600 | 650 | 725 | 805 | 880 |

Characteristics of electrical connections.

OPTIMAGAZ - CONDENSAGAZ

| Model – G Series... | G116 | G145 | G174 | G232 | G291 | G348 | G407 | G465 |
|---|--|------|------|------|---|------|------|------|
| Electric power consumption (boiler without accessories) (W) | 180 | 250 | 260 | 270 | 390 | 360 | 550 | 620 |
| Electric power supply (V) | 230 V AC +10 % -15 % 50 Hz | | | | | | | |
| Rated current without accessories (A) | 1,3 | 1,2 | 1,15 | 1,2 | 1,7 | 1,6 | 2,8 | 3,0 |
| Peak current without accessories (A) | 2,5 | | | | | | 3,0 | |
| Main fuse rating (excluding GUILLOT items) (A) | 12,5 | | | | | | | |
| Max length of probe cables | DHW probes: 10 m External probe: 30 m | | | | Ambient thermostat: 30 m Ambient probe: 30 m | | | |
| Power terminal outputs | 230 V AC +10 % -15 % 5 mA to 2 A | | | | | | | |

2 Installation.

The equipment must be installed and maintained by a qualified professional according to all current regulations and best professional practices applicable in the country where the boiler is installed.

The boiler must be installed in premises provided with ventilation openings in compliance with applicable regulations (see installation and maintenance manual).

3 Start-up.

Before shipping, all boilers undergo a works test with group H natural gas (type G20) during which all necessary adjustments are made. First start-up

must be carried out by our
Service Centre 0161 621 5960

For temporary start-up, proceed as follows:

1. Switch on the power (main on/off switch)
2. Create a heat demand in comfort mode by way of the client interface (see "Interface presentation" section)
3. After the burner has started up, check for leaks in the gas line using a foam-producing product. Check that combustion is safe and complete.
4. Adjust the clock. (See summary table of client parameters at the end of the manual).

Any interference with sealed parts will invalidate the warranty.

4 Shut-down.

To shut down the boiler, proceed as follows:

1. Switch off the main ON/OFF switch.
2. In the event of a prolonged shut-down close the isolating valve of the gas supply.

5 Maintenance.

Boiler maintenance must be carried out once a year (see Installation and Maintenance Manual).

Call on the services of a qualified professional for all maintenance operations (see Installation Manual).

6 Frost protection.

The guarantee remains valid only if the heating network is treated with anti-freeze when there is a risk of frost.

If it is decided nevertheless to drain the system, the user is responsible for ensuring that no water remains in the boiler.

- Close the gas supply isolating valve.
- Close the outlet and return stop-cocks.
- Open the safety valve to create an air inlet on the upper part of the boiler tubes; open the cock of the boiler drain tube.

- Switch off the main ON/OFF switch.

7 User interface and boiler management.

7.1 Presentation of the interface

The boiler's client interface comprises an on/off switch, a drawer-type fuse-holder, an electronic board with a backlit LCD screen (2 lines of 4 figures + pictograms) and 10 keys, and an opening for insertion of 2 96 x 96 regulators or 1 144 x 96 regulator.

All client settings and possible parameter adjustments are performed through this interface. It also allows the operator to consult information concerning boiler operation.

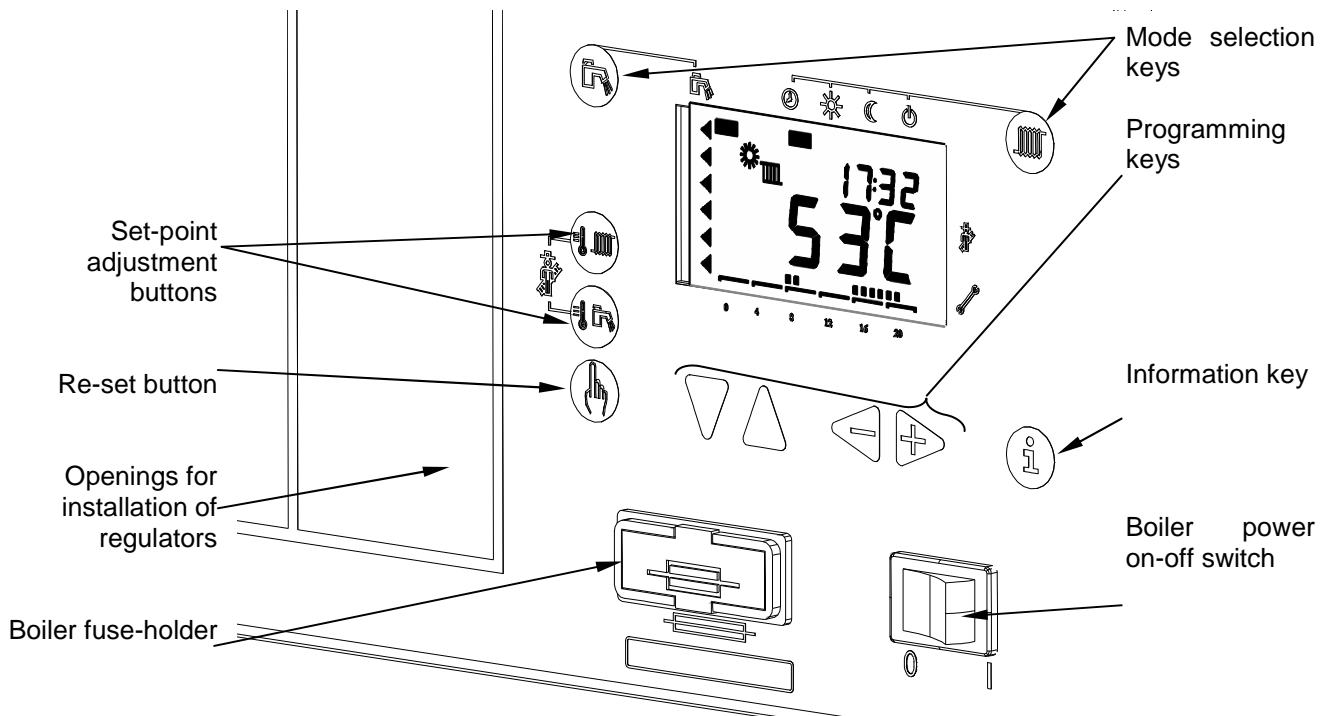

7.2 LCD display

The standard display presents the state of the boiler (operating mode, time, time programming, boiler temperature, flame presence, possible faults).

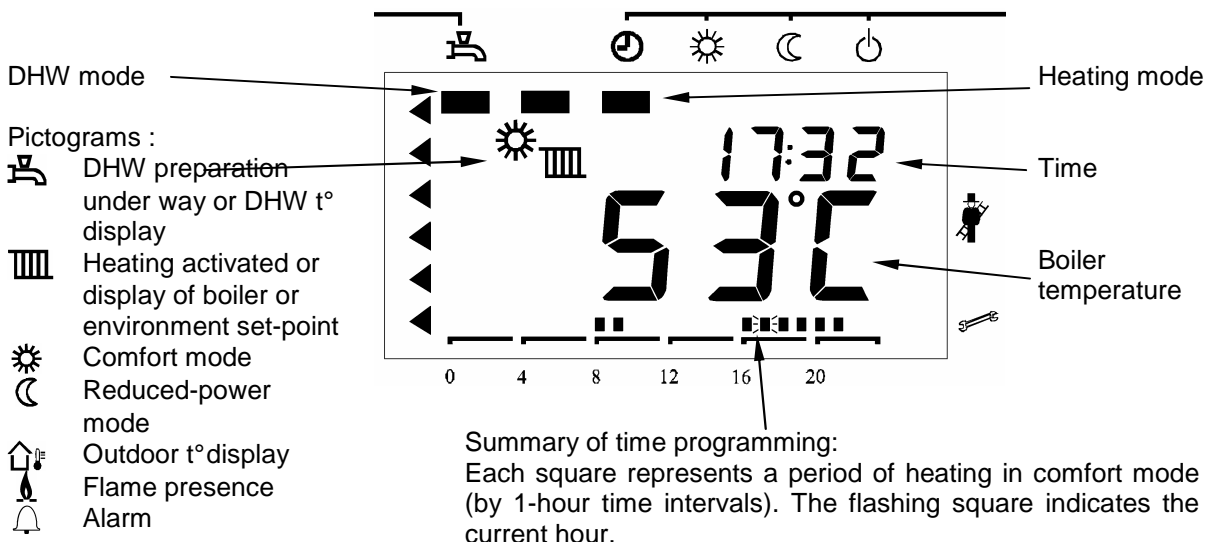



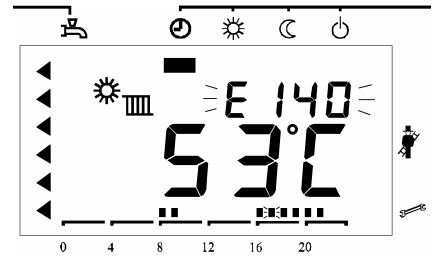



If a non-blocking fault occurs, the time display alternates with display of the fault code.
This type of defect does not lead to a shut-down.

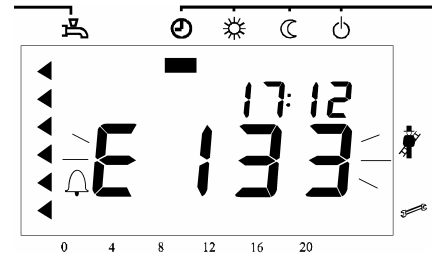

When a fault leads to boiler shut-down, a flashing display of the fault code replaces the boiler temperature display. An alarm bell is displayed in the bottom left corner of the display window.

Refer to the “Error message” section for information on the fault codes.



In both cases a brief pressure on the Information key  makes it possible to display only the fault code. Press keys  and  simultaneously for display of the extended fault code (Press , then  or  to return to standard display).

7.3 Operating modes

Heating mode key

For selection of heating mode among the Stop, Auto, Comfort and Eco modes

Stop

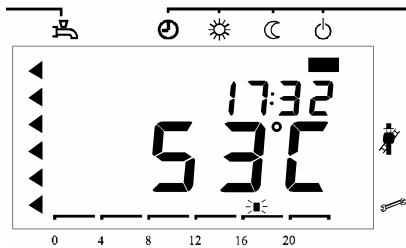

No heating demand has been received. The frost protection function is activated.

Comfort

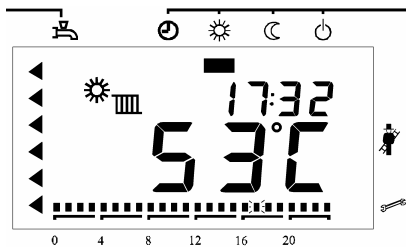

Permanent comfort mode.
Burner power is adjusted to maintain the heating set-point .

Eco

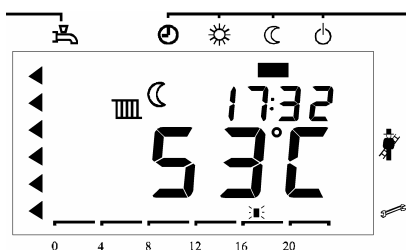

Permanent reduced-power mode.
Burner power is adjusted to maintain the reduced heating set-point. (Parameter n°5, see paragraph 7.6).

Auto

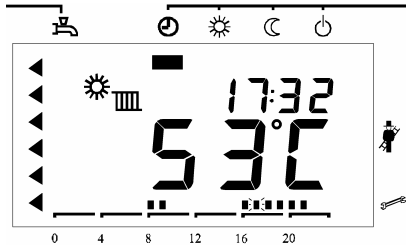

The regulator alternates Comfort and Eco modes, according to the time programming.

Two further “service” modes are available. They make it possible to carry out measurements on the boiler.

Flue cleaning

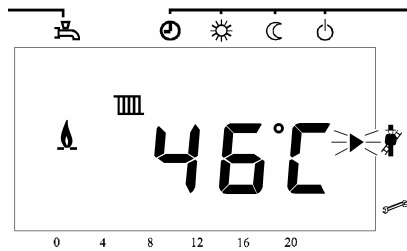

This mode allows the burner to operate at full load. Press and simultaneously for approximately 3 seconds

The burner starts up (if it was not already in operation) and power increases to provide maximum heat output.

The burner shuts down when the temperature limiting thermostat is triggered (88°C). This is a safety feature independent of the maximum operating temperature which cannot exceed 85°C.

While this function is activated, a forcing¹ signal is generated to evacuate heat.

Regulator off

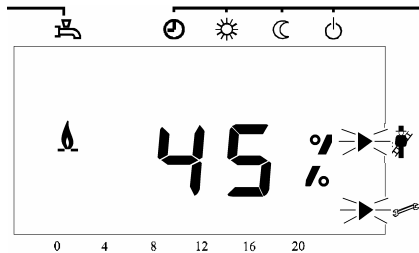

This mode allows burner heat output to be fixed manually

Press and simultaneously for approximately 6 seconds when in a standard mode or for 3 seconds when in the flue cleaning mode.

The relative² power set-point of the burner is displayed on the screen.

The and keys can be used to adjust the set-point value by 1 % steps. Keys and can be used to go directly to the min. or max. power set-point (0 % or 100 %)

To exit one of these two modes and return to standard operation, press and simultaneously for 1 second.

¹ Forcing signal: triggers pump start-up and/or opening of the 3-way valve of the connected heating circuits so as to evacuate heat. This signal is triggered by:

- Electronic temperature limiter.
- Safety thermostat.
- Flue cleaning mode
- Regulator off mode.
- Boiler frost protection.

² Relative power: this is the actual power output of the burner with respect to its modulation range. 0 % corresponds to minimum power and 100 % to maximum power of the boiler.

To convert this to a percentage of heat output (or load factor), the following formula can be used:

$$\%Q_{cal} = \frac{Power_{relative} \cdot (100 - \%Q_{min})}{100} + \%Q_{min} = 0.75 \cdot P_{rel} + 25$$

| Displayed percentage | 100 | 90 | 80 | 70 | 60 | 50 | 40 | 30 | 20 | 10 | 0 |
|----------------------|-----|------|----|------|----|------|----|------|----|------|----|
| Load factor (%) | 100 | 92.5 | 85 | 77.5 | 70 | 62.5 | 55 | 47.5 | 40 | 32.5 | 25 |

DHW Mode key

Activates / disactivates the production of domestic hot water

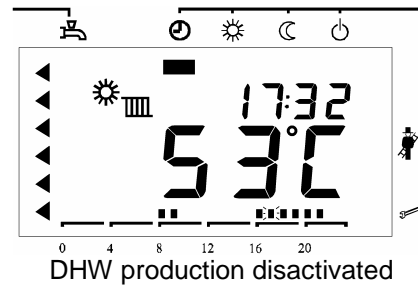
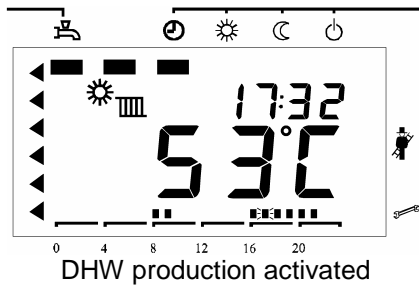



7.4 Set-point adjustment



Adjustment of the heating set-point

According to the mode of regulation chosen, the set-point temperature can have different meanings:

- ✓ In constant temperature mode, the set point is a boiler outlet water temperature.
- ✓ In regulated mode, depending on outside temperature or ambient temperature, or both, the set point is an ambient temperature.

Press the heating set-point key . The current set-point is displayed.

Use the  or  key to adjust the heating set point temperature.

To exit the set point adjustment screen press the heating mode , DHW mode , or heating set point  key.

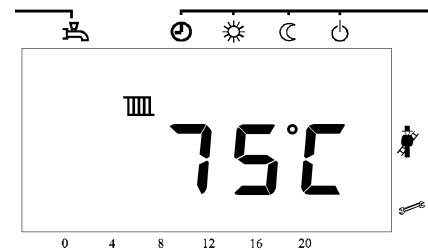

If no key is pressed the interface returns to the standard display after about 8 minutes.





Adjustment of DHW set point

This function is available only if DHW production is connected to the boiler.

Press the domestic hot water set point key . The current value of the set point is displayed.

Use the  or  key to adjust the DHW set point temperature.

To exit the set point adjustment screen press the heating mode , DHW mode , or DHW set point  key.

If no key is pressed the interface returns to the standard display after about 8 minutes.

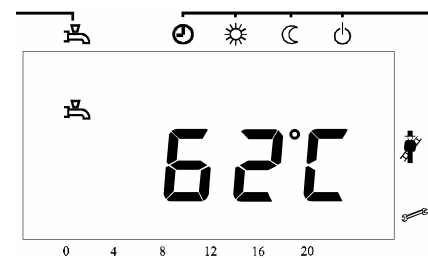

7.5 Information on boiler status

Info key

At any moment basic information on the boiler can be obtained by pressing the Info key . Each



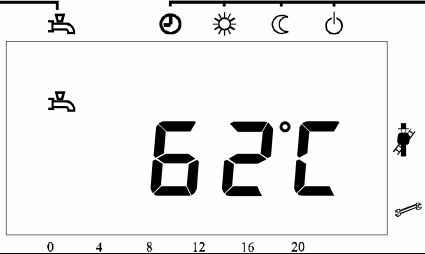
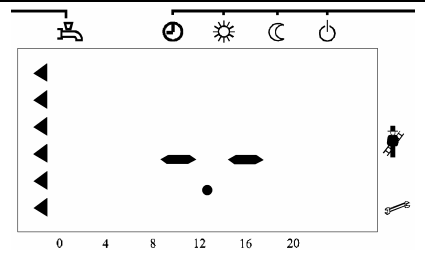
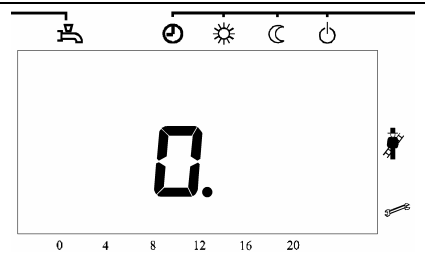
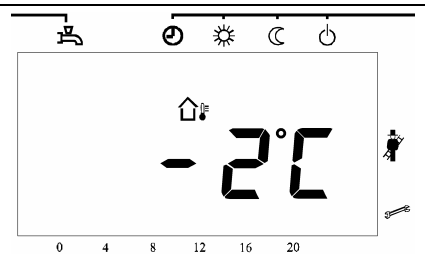
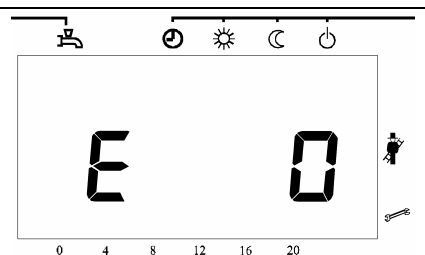
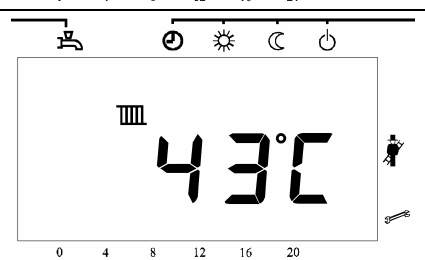



pressure on  moves the display to the following variable.



| | | |
|---|--|--|
| 1 | DHW temperature |  |
| 2 | Not used |  |
| 3 | Burner operation phase code (see section on “ <i>Burner phase codes</i> ”) |  |
| 4 | Outside temperature |  |
| 5 | Albatros ³ error code (see section on “ <i>Error messages</i> ”) |  |
| 6 | Boiler temperature |  |

To return to standard display, press the  or  key.

³ Albatros: name given by SIEMENS to the fault codes.

Table of additional information

From the Info mode (one pressure on the Info key ) , it is possible to obtain additional data concerning boiler operation. For this, press  and  simultaneously for about 3 seconds. The time display is replaced by an address composed of a letter (b, C, d) and a figure (from 0 to 7). Use keys  and  to modify the letter. Use keys  or  to modify the figure.

Press key  to return to Info mode or  or  to return to the default display.

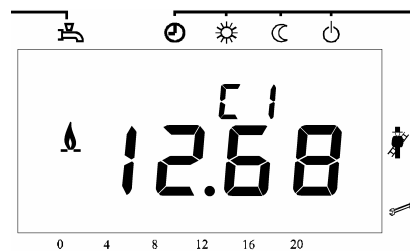

| Address | Information |
|----------------|---|
| b0 | Extended fault code |
| b1 | Return probe temperature |
| b2 | - |
| b3 | Flue gas temperature |
| b4 | External temperature probe |
| b5 | Composite outside temperature |
| b6 | Attenuated outside temperature |
| b7 | 3-way valve kit outlet temperature probe |
| C1 | Ionisation current (μA) |
| C2 | Measured fan speed |
| C3 | Measured fan PWM Signal |
| C4 | Relative power (see ² page 9) |
| C5 | - |
| C6 | Actual difference set point / measured value |
| d1 | Set point for boiler temperature (including DHW and other heating circuits) |
| d2 | Heating temperature set point |
| d3 | Ambient temperature set point |
| d4 | DHW temperature set point |
| d5 | Level of modulation of max. fan speed in heating mode |
| d6 | Max. speed in heating mode |

Error messages

In the event of a fault leading to shut-down, the alarm signal is permanently displayed and the fault code flashes. To reset the system, correct the fault and then press the reset button  for at least 2 seconds.

| Albatros number | Interpretation |
|------------------------|--|
| 0 | No input in Albatros code – no defect |
| 10 | External probe fault |
| 20 | Boiler probe fault |
| 28 | Flue gas probe fault |
| 32 | Clip-in probe fault |
| 40 | Return probe fault |
| 50 | DHW probe fault |
| 61 | Ambient temperature regulation: Failure |
| 62 | Ambient temperature regulation: error or radion clock error |
| 81 | Short-circuit on LPB bus or bus power supply failure |
| 82 | Address collision on LPB bus (several identical addresses) |
| 91 | Data loss in EEPROM |
| 92 | Equipment fault in electronic part |
| 100 | Two master clocks in system |
| 105 | Maintenance alert |
| 110 | Safety thermostat triggered (electronic or mechanical) |
| 111 | Triggering of limiting thermostat |
| 113 | Excess over authorized flue gas temperature |
| 128 | Flame failure during operation |
| 129 | Poor air supply |
| 130 | Power limitation due to excessive flue gas temperature |
| 132 | Response of gas pressure switch |
| 133 | No flame formation after expiry of safety period |
| 140 | Segment number or LPB equipment number inadmissible |
| 148 | LPB and LMU communication interfaces not compatible |
| 151 | Internal LMU fault |
| 152 | LMU parameter error |
| 153 | Equipment in locked position |
| 154 | Inconsistency in Flow or Return or Ambient or ECS temperatures |
| 160 | Fan threshold speed not reached |
| 161 | Maximum fan speed exceeded |
| 162 | Air pressure switch not closed |
| 164 | Response of flow controller / low water level contact |
| 166 | Air pressure switch not open |
| 180 | Flue cleaning function activated |
| 181 | Regulator off function activated |
| 183 | Equipment in parameter setting mode |









Burner phase codes

To consult the burner phase codes, press the Info key  3 times, as indicated in the “Info key” section

| Phase code | Interpretation |
|-------------------|--|
| 0 | Stand-by (no heat demand) |
| 1 | Start-up blocked |
| 2 | Fan ramping up to speed |
| 3 | Preventilation |
| 4 | Waiting time |
| 5 | Pre-ignition time |
| 6 | Safety period |
| 10 | Heating mode |
| 11 | DHW mode |
| 12 | Parallel heating and DHW operation |
| 20 | Post-ventilation |
| 22 | Return to initial position |
| 99 | Failure position (display of current fault code) |

7.6 Parameter setting



To optimize boiler configuration, the final user or the installer can modify a certain number of parameters. To ensure security of the boiler configuration, not all parameters are accessible to the final user. They are therefore grouped according to level of access.

From the standard display, access the parameter setting mode – final user level – by pressing the  or  key. The screen then displays a P followed by a 3-figure parameter number. With the  and  keys it is possible to scroll through the list of parameter numbers. When the desired parameter is displayed, adjust its value with the  and  keys. The new value is validated as soon as you select the previous or next parameter or when you exit the mode by pressing the  key. Beware, if you exit the programming mode by means of the  or  key the modification of the current parameter will not be validated.

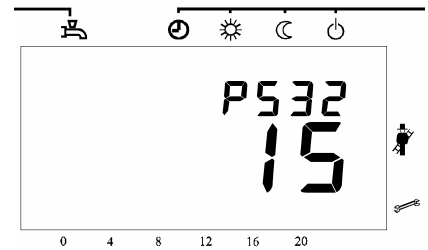
Consult the client parameter summary table at the end of this manual.



Parameters accessible at installer level

From the parameter setting mode, final user level, access the installer level by pressing the  and  keys simultaneously for 3 seconds. The letter P is then replaced by an H.

Consult the client parameter summary table at the end of this manual.



8 Operation of control cabinet.

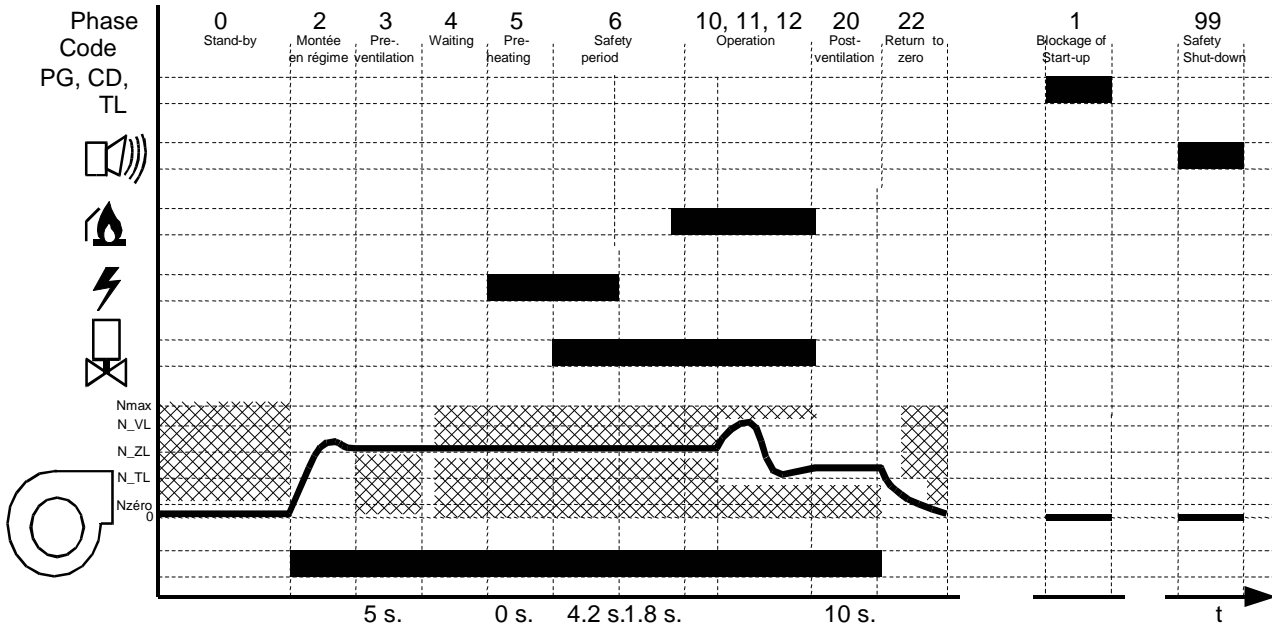

Legend:

PG = Gas pressure switch
 CD = Flow controller
 TL = Limiting thermostat



= Alarm



= Flame detection



= Ignition electrode



= Gas valve



= Fan

Nmax = Maximum speed authorized
 N_VL = Maximum speed authorized during modulation.
 N_ZL = Ignition speed
 N_TL = Minimum speed authorized during modulation.
 Nzero = Speed less than 200 rpm so considered as nil

Fan speed

9 List of parameters

Summary table of client parameters

Boiler: site :
 Serial number:

Please note all modifications to parameters in this document !

| Adjustment line | Function | Adjustment range | Default value | Client setting |
|---|---|---|---------------|----------------|
| <i>Clock adjustment</i> | | | | |
| P 1 | Time (current) | 00:00... 23:59 | --- | |
| P 2 | Day (current) | 1: Monday- 7: Sunday | --- | |
| P 5 | Low outlet set point / Low ambient set point (according to mode) | 20...80 / 10...26 °C | 40 / 15 | |
| <i>Time programming of direct heating circuit</i> | | | | |
| <u>Preselection of day(s) to be programmed:</u> | | | | |
| P 10 | 1-7 Complete week 1...7 Day of the week | 1-5 Monday to Friday 6-7 Saturday and Sunday | 1-7 | |
| P 11 | Start 1st period | 0:00... 24:00 | 06:00 | |
| P 12 | End 1st period | 0:00... 24:00 | 22:00 | |
| P 13 | Start 2 nd period | 0:00... 24:00 | --:-- | |
| P 14 | End 2 nd period | 0:00... 24:00 | --:-- | |
| P 15 | Start 3rd period | 0:00... 24:00 | --:-- | |
| P 16 | End 3rd period | 0:00... 24:00 | --:-- | |
| P 20 à 26 | Not used | | | |
| <i>Time programming of domestic hot water (DHW)</i> (activated depending on configuration) | | | | |
| <u>Preselection of day(s) to be programmed:</u> | | | | |
| P 30 | 1-7 Complete week 1...7 Day of the week | 1-5 Monday to Friday 6-7 Saturday and Sunday | 1-7 | |
| P 31 | Start 1st period | 0:00... 24:00 | 06:00 | |
| P 32 | End 1st period | 0:00... 24:00 | 22:00 | |
| P 33 | Start 2 nd period | 0:00... 24:00 | --:-- | |
| P 34 | End 2 nd period | 0:00... 24:00 | --:-- | |
| P 35 | Start 3rd period | 0:00... 24:00 | --:-- | |
| P 36 | End 3rd period | 0:00... 24:00 | --:-- | |
| P 45 | Return to standard time programming for heating and DHW. (press – and + keys simultaneously for 3 seconds) | | 0 | |
| H 90 | Low set point for DHW temperature | 50...65 °C | 65 | |
| H 91 | Liberation of DHW production: 0 DHW time programming 1 24h/24 | | 0 | |
| H 93 à 94 | Not used | | 0 | |
| <i>Settings for heating circuits</i> | | | | |
| H 505 | Maximum heating set point temperature | 65...90 °C | 87.0 | |
| H 510 | Over-rise in the instruction of starting temperature for the head of hot water medical | 0...30 K | 15 | |
| P 532 | Slope of direct circuit heating characteristics | 1 ... 40 | 22 | |
| H 534 | Correction of ambient set point for direct heating circuit | -31 ... 31 K | 0.0 | |
| <i>Boiler configuration</i> | | | | |
| H 536 | Maximum fan speed in heating mode | 0 ... 9950 rpm | See below | |
| | G116 G145 G174 G232 G291 G348 G407 G465 | | | |
| | OPTI CON. OPTI CON. OPTI CON. OPTI CON. OPTI CON. OPTI CON. OPTI CON. OPTI CON. | | | |
| | 7050 7000 5850 5850 5950 5750 5500 5400 6200 6200 6000 5850 5300 5200 5550 5550 | | | |
| H 542 | Minimum boiler power output | 0 ... 9999 kW | acc. to model | |
| H 543 | Maximum boiler power output | 0 ... 9999 kW | acc. to model | |
| H 544 | Time delay to shut-down of pump Q1 or to closure of isolating valve Y1, max. 218 min. (255 = permanent operation of Q1 or permanent opening of Y1) | 0 ... 255 min | 5 | |
| H 545 | Minimum burner pause time | 0 ... 3600 sec | 300.0 | |

| Adjustment line | Function | Adjustment range | Default value | Client setting |
|--|--|------------------|---------------|----------------|
| H 552 | Installation configuration setting: 66 Stand-alone boiler 80 Boiler in cascade installation | | 66 | |
| H 553 | Influence of ambient temperature probe on heating circuit (only with ambient control unit) : Units: influence on direct circuit (DC) Tens: not used 0 Direct circuit not influenced by ambient temperature probe 1 Direct circuit controlled by ambient temperature probe 2 Inactive <i>ex : 01 corresponds to a direct circuit controlled by the ambient temperature probe</i> | | 0 | |
| H 555.b0 | Not used | | 0 | |
| H 555.b1 | Type of DHW priority: 0 Absolute priority 1 No priority | | 0 | |
| H 555.b2 à b3 | Not used | | 0 | |
| H 555.b4 | Frost protection of installation : 0 out of use 1 In use | | 1 | |
| H 555.b5 - b7 | Not used | | 0 | |
| H 558.b0 | Not used | | 0 | |
| H 558.b1 | Type of construction : 0 Lightweight 1 Heavyweight | | 0 | |
| H 558.b2 | Type of DHW control device: 0 Probe 1 Thermostat | | 0 | |
| H 558.b3 - b7 | Not used | | 0 | |
| Communication by LPB bus | | | | |
| H 604.b0 | Synchronisation of local / system clock: b1 b0 0 0 Independent clock | | 0 | |
| H 604.b1 | 0 1 System time without adjustment 1 0 System Master Clock | | 0 | |
| H 604.b2 | Setting of bus supply: 0 Centralized supply 1 Automatic supply by regulators | | 1 | |
| H 604.b3 | Display of bus supply : 0 OFF 1 ON | | 0 | |
| H 604.b4 | Not used | | 1 | |
| H 604.b5 | Allocation of DHW to consumers: b6 b5 0 0 Local consumers only, | | 0 | |
| H 604.b6 | 0 1 Consumers of same segment, 1 0 All consumers of system | | 0 | |
| H 604.b7 | Priority of LPB bus over power demand via 0 ... 10 V input: 0 priority to external power demand 1 priority to LPB bus | | 0 | |
| H 605 | Device address I | 0 ... 16 | 1 | |
| H 606 | Segment address: 0 generator segment 1 ... 14 consumer segments | 0 ... 14 | 0 | |
| H 615 | Function of programmable output K2 of LMU : 0 Inactive 7 Signal for hot air curtain function active 2 External alarm 8 Downstream pump for balancing vessel 3 Burner operating 9 Pump Q8 6 Pump of DHW network 12 0-10 V input active | | | |
| Input / Output relay-operated Clip-ins (AGU2.51x) | | | | |
| H 618 | Function of programmable input of clip-in : 0 Inactive 3 Hot air curtain 1 Modem 4 Prescribed set point 2 Modem reverser 5 Prescribed power | | 0 | |
| H 619 | Function of the 1st programmable output of clip-in : 0 Inactive 7 Signal for hot air curtain function active 2 External alarm 8 Downstream pump for balancing vessel 3 Burner operating 12 0-10 V input active 6 Pump of DHW network | | 3 | |
| H 620 | Function of the 2nd programmable output of clip-in : 0 Inactive 7 Signal for hot air curtain function active 2 External alarm 8 Downstream pump for balancing vessel 3 Burner operating 12 0-10 V input active 6 Pump of DHW network | | 12 | |
| H 622 | Temperature set point for an input signal equal to 10 V, in prescribed set point mode (H618 = 4). | 5 ... 130 °C | 100 | |
| H 623 | Threshold of 0 ... 10V (x10) signal to authorize burner operation at minimum power, in prescribed power mode (H618 = 5) | 5 ... 95 | 25 | |
| Maintenance alerts | | | | |
| P 629 | Temporary acknowledgement of maintenance alert: 1 Acknowledgement | | 0 | |

| Adjustment line | Function | Adjustment range | Default value | Client setting |
|-----------------|---|------------------|---------------|----------------|
| H 630.b0 | Activation / disactivation of maintenance alert: 0 Alert disactivated 1 Alert active | | 0 | |
| H 630.b1 à b5 | Not used | | 0 | |
| H 630.b6 | General acknowledgement of maintenance alert: 1 Acknowledgement | | 0 | |
| H 630.b7 | Not used | | 0 | |
| H 632.b0 | Pump Q8 active for LPB heat demand : 0 No 1 Yes | | 0 | |
| H 632.b1 | Not used | | 0 | |
| H 632.b2 | Pump Q8 active for a direct heating circuit heat demand: 0 No 1 Yes | | 0 | |
| H 632.b3 | Pump Q8 active for a DHW heat demand: 0 No 1 Yes | | 0 | |
| H 632.b4 à b7 | Not used | | 0 | |
| H 634 | Burner operating time in hours since last maintenance | | 0 | |
| H 635 | Number of burner start-ups since last maintenance | | 0 | |
| H 636 | Boiler operating time in months since last maintenance | | 0 | |
| | Fault / Counter log | | | |
| H 700 | <i>Counter of repetitions of logged fault n°1</i> | | | |
| H 701 | <i>Burner phase during logged fault n°1 * (see below)</i> | | | |
| H 702 | <i>Extended code of logged fault n°1</i> | | | |
| H 703 | <i>Counter of repetitions of logged fault n°2</i> | | | |
| H 704 | <i>Burner phase during logged fault n°2 * (see below)</i> | | | |
| H 705 | <i>Extended code of logged fault n°2</i> | | | |
| H 706 | <i>Counter of repetitions of logged fault n°3</i> | | | |
| H 707 | <i>Burner phase during logged fault n°3 * (see below)</i> | | | |
| H 708 | <i>Extended code of logged fault n°3</i> | | | |
| H 709 | <i>Counter of repetitions of logged fault n°4</i> | | | |
| H 710 | <i>Burner phase during logged fault n°4 * (see below)</i> | | | |
| H 711 | <i>Extended code of logged fault n°4</i> | | | |
| H 712 | <i>Counter of repetitions of logged fault n°5</i> | | | |
| H 713 | <i>Burner phase during logged fault n°5 * (see below)</i> | | | |
| H 714 | <i>Extended code of logged fault n°5</i> | | | |
| H 715 | <i>Counter of repetitions of current fault</i> | | | |
| H 716 | <i>Burner phase during current fault * (see below)</i> | | | |
| H 717 | <i>Extended code of current fault</i> | | | |
| H 718 | <i>Burner operating time</i> | 0 ... 131070 h | 0 | |
| H 719 | <i>Operating time in heating mode</i> | 0 ... 131070 h | 0 | |
| H 720 | <i>Operating time in DHW mode</i> | 0 ... 131070 h | 0 | |
| H 721 | <i>Operating time in zone regulation mode</i> | 0 ... 131070 h | 0 | |
| H 722 | <i>Start-up counter</i> | 0 ... 327675 | 0 | |
| H 728 | <i>Albatros Code of logged fault n°1</i> | | | |
| H 729 | <i>Albatros Code of logged fault n°2</i> | | | |
| H 730 | <i>Albatros Code of logged fault n°3</i> | | | |
| H 731 | <i>Albatros Code of logged fault n°4</i> | | | |
| H 732 | <i>Albatros Code of logged fault n°5</i> | | | |
| H 733 | <i>Albatros Code of current fault</i> | | | |

In italics: read-only parameters

* : Correspondance of burner phase codes:

| | | | |
|----------|-----------------------------|----------------|--|
| 0, 1, 2 | Return to stand-by position | 11 | Pre-ignition (heating of ignition electrode) |
| 3 | Stand-by | 12, 13, 14, 15 | Safety period |
| 4 | Blockage of start-up | 16 | Post-ignition (maintenance of ignition rate) |
| 5, 6 | Fan ramping up to speed | 17 | Burner modulation |
| 7 | Preventilation | 18, 19, 20, 21 | Post-ventilation |
| 8, 9, 10 | Waiting position | 22 | Safety shut-down |